

# Fire doors hardware

TESA

ASSA ABLOY

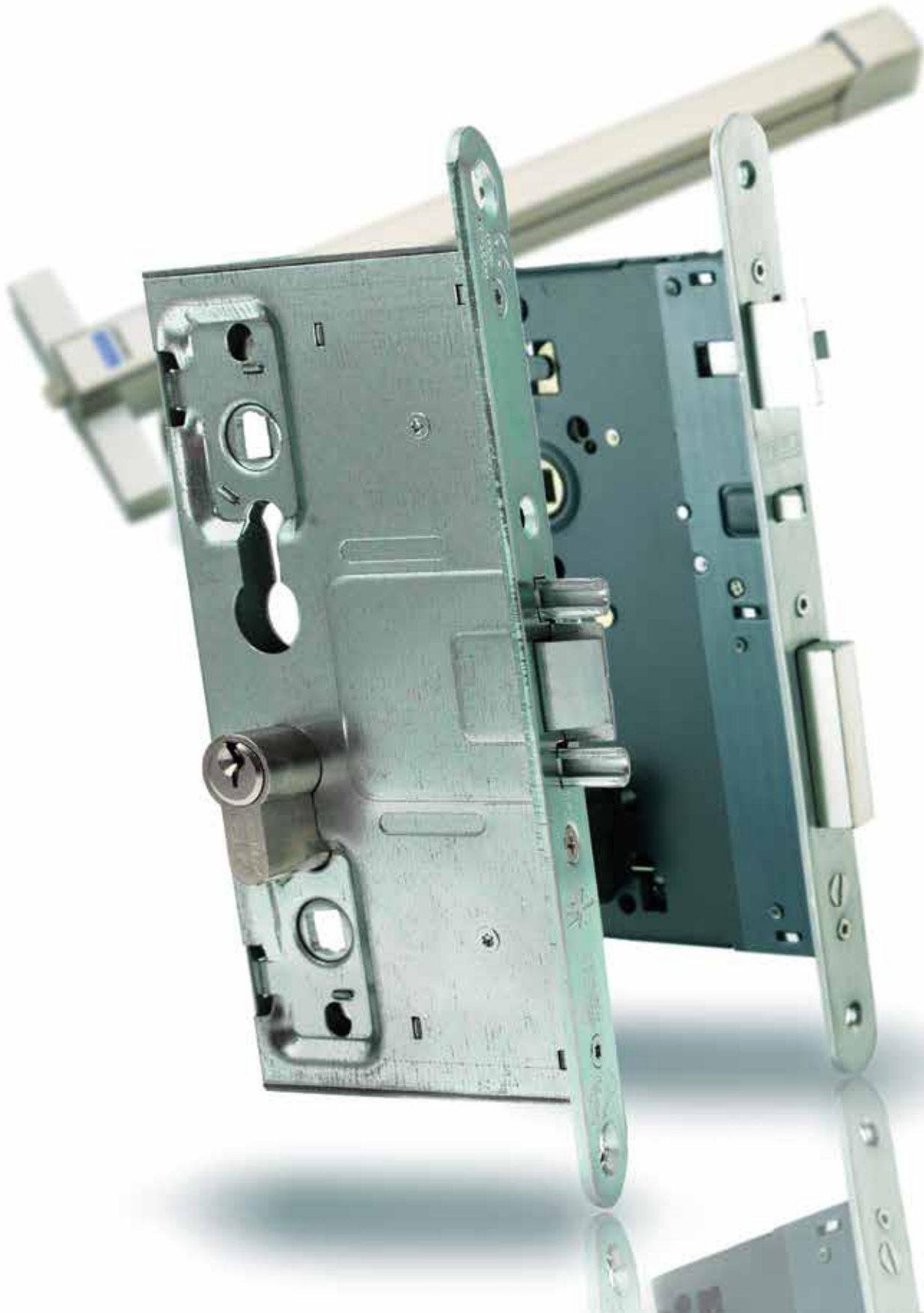

## Safety and security, our main goals.



Worse than being in an emergency situation is to be unprepared to face it. TESA's fire doors locks have been manufactured for maximum resistance in case of arson, and they are an efficient protection against fire: they can be installed in RF doors

that prevent the transmission of smoke and gas, prevent the flames and heat from entering, avoid inflammation on the side of the door that hasn't been exposed to fire... As you see, TESA cares about your safety even in the worst situations.

## Safety and security, our main goals.

One thing is worse than being in an emergency situation: to be unprepared to face it. TESA's firebreak locks have been manufactured for maximum resistance in case of arson, and they are an efficient protection against fire: they can be installed in RF doors that prevent the transmission of smoke and gas, prevent the flames and heat from entering, avoid inflammation on the side of the door that hasn't been exposed to fire... As you see, TESA cares about your safety even in the worst situations.



## In case of fire, nothing must fail

By firebreak fittings we mean all the elements that take place in tests of resistance against fire in doors, such as locks, hinges, door closers, handles, panic bars, etc.

The purpose of these fittings is to keep the door closed in order to avoid transmission of smoke and gas and prevent the flames and heat from entering, therefore avoiding inflammation on the side of the door that hasn't been exposed to fire.

## A wide range

A good reason to choose TESA. From cost-competitive technical products to electromechanical solutions, all in keeping with the latest design trends.



## Total integration

TESA has decided to reinforce the reliability of its products, and to this effect many of them have been EC certified. This guarantees the highest performance and features in TESA's products. The UNE-EN 12209 standard, updated in 2004, which refers to "Fittings for Buildings – Locks and Bolts", must be complied with when it comes to mechanical locks with strikes that have been installed on doors, windows and entrance doors.

These standards establish a series of tests and requisites for:

- Durability
- Resistance
- Security

## Guaranteed by TESA

Since the company was born in 1941, our whole range has always guaranteed a total commitment to integral quality. Proof of this commitment is the ISO 9001 quality certification (received in 1994) and the ISO 14001 environmental management certification (in 1999), which makes TESA a pioneering company in the industry.



# Fire doors hardware



Wooden doors							Metallic doors	
Panic function			No panic function				Panic function	No panic function
High security	Entrance	Passage	High security	Entrance	Passage			
2030A		*						
2030E					*			
2039F					*			
2035F						*		
TLPN				*				
TLBA	*							
CF50								*
CF60							*	

## Contents

<b>Fire doors hardware</b>	<b>6</b>
2030 Series	6
CF-50 Series	7
CF-60 Series	7
Counter lock CF-32	8
Counter locka 2032F	9
2UBOF Series	11
<b>Handles for institutional buildings</b>	<b>12</b>
Sena Series	13
Monobloc Series	14
Security multipoint locks	
TLPN and TLBA	16
Spindles and reducers	17
LITE - QUICK - Universal - TOP Series	18
Hinges for certified firebreak doors	19
Stainless Steel hinge	19



2030F series



CF series



TLP / TLB series



Panic exit devices



Hinges



Handles

# Fire doors hardware

## 2030 Series

- » Sintered steel latch: endures temperatures over 900° C.
- » 8x8 mm follower rod.
- » Distance between each axis: 85 mm.
- » With panic function (always free passage from the inside), except in the 4030E model). In case of simple follower, a protective device for the follower is installed inside to prevent the handle from being activated. In case of double follower rod, the lock is reversible.

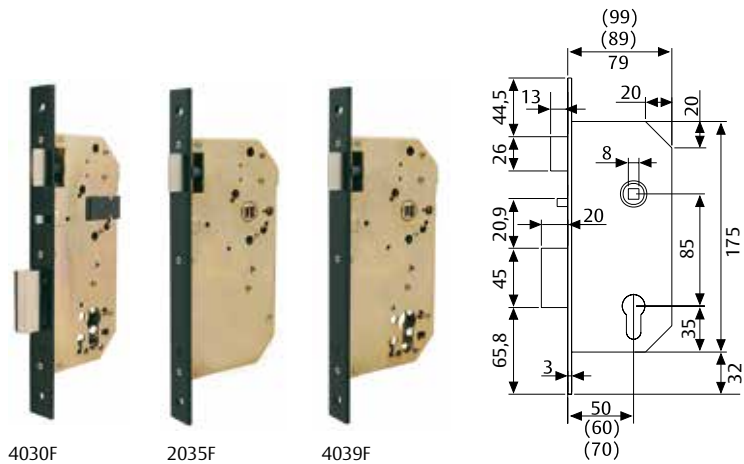

Model	Follower rod	Backset	Security Device	Finish	External operation	Internal operation	Field of use
2030F60	Through	50 / 60 / 70	Yes	NE / AI / HL	Pull handle + key	Handle	Entrance doors
2030F6	Split/Reversible	50 / 60 / 70	No	NE / AI / HL	Handle/pull handle + key	Handle + key	Entrance doors
2035F60	Through	50 / 60	No	NE / AI	Handle	Handle	Passage doors
4039F60	Through	50 / 60	No	NE / AI	Key	Handle	Entrance hall, garage
4030T6(L/R)	Split	60	No	NE / AI / HL	Handle/pull handle + key	Panic bar	Emergency exit
2035TR6(L/R)*	Split	60	No	NE / AI	Handle + key	Panic bar	Emergency exit
4039TR6(L/R)*	Split	60	No	NE / AI	Handle/pull handle + key	Panic bar	Entrance hall, garage
4030S6	Split/Reversible	50 / 60 / 70	No	NE / AI	Handle/pull handle + key	Handle + key	Entrance doors
4030E6S	Through		Yes	NE / AI	Handle/pull handle + key	Handle + key	Entrance doors

### 2030F: panic lock with anti-thrust device

Follower rod	Model	Entrance	Hand	Finish
Standard	2035F	50 / 5R	-	NE
	2035F	50 / 5R	-	AI
	2035F	60 / 6R	-	NE
	2035F	60 / 6R	-	AI
Standard	2035F	60 / 6R	-	HL
	2039F	50 / 5R	-	NE
	2039F	50 / 5R	-	AI
	2039F	60 / 6R	-	AI
Standard	2030F	50 / 5R	-	NE
	2030F	50 / 5R	-	AI
	2030F	5R	-	HL
	2030F	60 / 6R	-	NE
	2030F	60 / 6R	-	AI
	2030F	60	-	HL

### 2030E: not panic with anti-thrust device

Follower rod	Model	Finish	1/2 rounded forend
Standard	4030E6SNE	Black	-
	4030E6SAI	Stainless steel	-
	4030E6SNR	Black	YES
	4030E6SRI	Stainless steel	YES
	4030E6SHR	Brass plated	YES

### 2030FR: not panic with anti-thrust device, Reversible.

Follower rod	Model	Entrance	Hand	Finish
Split follower	2030FRS	50 / 5R	Reversible	NE
	2030FRS	50 / 5R	Reversible	AI
	2030FRS	50 / 5R	Reversible	HL
	2030FRS	60 / 6R	Reversible	NE
	2030FRS	60 / 6R	Reversible	AI
	2030FRS	60 / 6R	Reversible	HL

Underline: "Express 5" service.

No underline: 15 working days maximum.



# Fire doors hardware

Model	Follower rod	Panic function	Outside access device	Internal operation	Performance	Field of use
CF50ASR9	Split	Yes	Handle/pull handle + key	Handle + key	The key removes the lever and the latch	Entrance
CF50NG	Through	No	Pull handle/handle + key	Handle + key	The key removes the lever and the latch	Entrance
CF60RSR9	Split	Yes	Handle/pull handle + key	Handle + key	The key deadlocks the external handle	Entrance
CF6TRSR9*	Split	Yes	Handle/pull handle + key	Panic bar	The key deadlocks the external handle	Emergency exit
CF6900R9	Through	Yes	Pull handle/handle + key	Handle	External opening with a key	Entrance
CF6500R9Z	Through	Yes	Handle	Handle	Free passage by both sides	Free passing doors

\* Strike included

## CF-50 Series

- » Lock suitable for use on fire rated doors.
- » Steel latch: working temperature > 900°C.
- » 9x9mm follower.
- » Distance between axes: 72 mm.
- » Backset: 65 mm.
- » Reversible.
- » Zinc plated steel (Z) or stainless steel (I) frontplate.
- » Durability: 200.000 cycles @ 120N pre-load.
- » Additional security features:
  - 1) New deadbolt design (increased stiffness).
  - 2) When cylinder is locked and deadbolts projected the latch remains blocked and it can not be retracted.
  - 3) When cylinder is locked the latch activates a deadlatch system.



CERTIFIED ACCORDING  
**UNE-EN  
12209:2004**

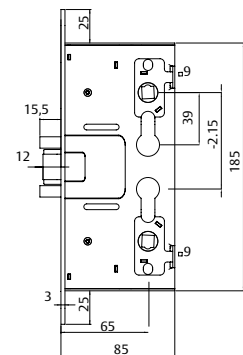

Product code	Function	Packaging
CF50NGTR9Z/ICE	No panic	1 / 25
CF5ENGTR9Z/ICE	No panic	1 / 1
CF50ASR9Z/ICE *	Panic	1 / 25

\* Split follower

## CF-60 Series

- » CF60 lock, cylinder not included, panic function for all versions
- » Suitable to be used in FR doors
- » Certified according UNE-EN1125:2009
- » Certified according UNE-EN 12209: 2004.
- » Steel latch, suitable to be used in FR doors
- » Non-friction guide between latch and frontplate
- » 9x9 mm follower
- » Backset 65 mm
- » Distance between each axis 72 mm
- » Reversible (non handed)
- » Front plate finish: zinc plated (Z) or stainless steel (I)

CERTIFIED ACCORDING  
**UNE-EN  
12209:2004  
1125:2009**

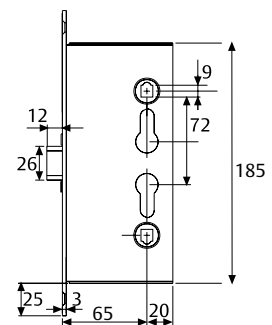

Product code	Function	Packaging
CF60RSR9(Z/I)CEROB	Handle/panic bar+key	1 / 25
CF6TRSR9(Z/I)CEROB	Handle/panic bar+key *	1 / 1 y 1 / 20
CF6ERSR9(Z/I)CEROB	Handle/panic bar+key	1 / 1 y 1 / 20
CF6IRSR9ICEROB	Inwards opening	1 / 25
CF6500R9(Z/I)CEROB	Free passing door**	1 / 25
CF6900R9(Z/I)CEROB	External key opening (without lever) ***	1 / 25

\* Strike included

\*\* No cylinder admitted (only external lever handle)

\*\*\* No external lever handle is admitted (only external cylinder)

# Fire doors hardware

## Counter lock CF-32

### Features:

- » Counterlock for double leaf doors, to be installed in passive leaf.
- » It can be installed with CF60 or CF50 on the main leaf.  
CF50 is not valid for panic exit device solution
- » CE certified according to EN1125:2008 (when installed with CF60 on the main leaf).
- » Suitable for FR doors.
- » 72mm distance between axes.
- » Backset: 65mm.
- » Can be operated manually or through the panic bar.
- » When operating the counterlock, the CF32 actuator pushes back the main leaf lock latchbolt and retracts the top and bottom rods at the same time.
- » Complete lock set consists of a central main lock, two vertical rods with bolts and a top relatching device.

CERTIFIED ACCORDING  
**UNE-EN  
1125:2009**

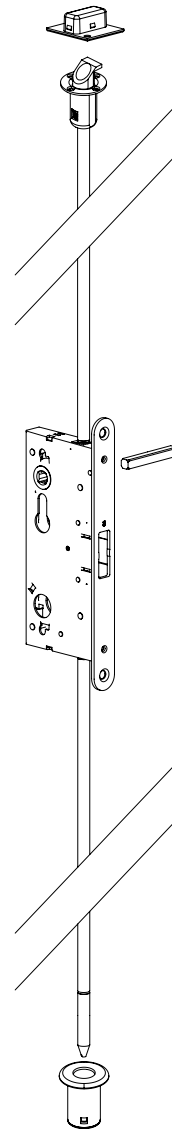
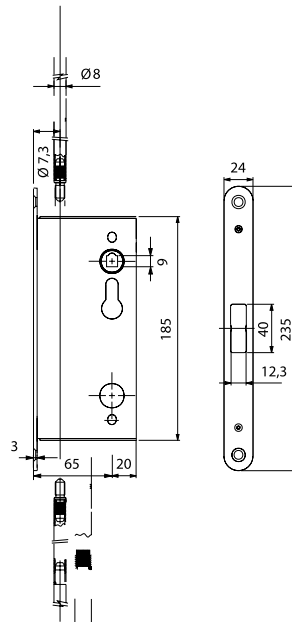

Product code	Function	Packaging
RETCF32R	Vertical rod relatching device	1 / 25
CF322EN1SR9Z/ICE	Counterlock	1 / 1 and 1 / 20
BARVECF32CE	Vertical rod device	1 / 25



# Fire doors hardware

## Counter lock 2032F

### Features:

- » Counterlock for double leaf doors, to be installed in passive leaf.
- » It can be installed with 2035T, 2037F and 2039T on the main leaf.
- » CE certified according to EN-1125: 2008.
- » Suitable for FR doors. EN 1634-1:2014.
- » 85 mm distance between axes.
- » Backset: 60mm.
- » Stainless Steel made reversible ½ rounded frontplate.
- » Can be operated manually or through the panic bar.
- » When operating the counterlock, the 2032F actuator pushes back the main leaf lock latchbolt and retracts the top and bottom rods at the same time.
- » Complete lock set consists of a central main lock, two vertical rods and a top and bottom locking point.

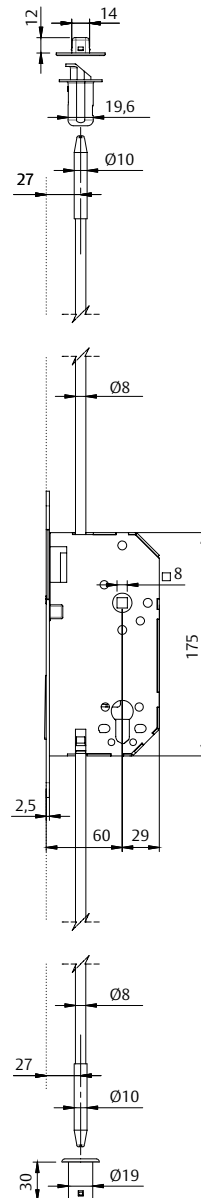
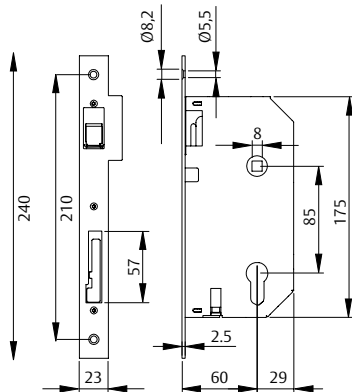

Product code	Function	Packaging
2032F6RAI	Central main lock	
BARVE2032FCE	Vertical rods, for top and bottom locking points	
RETCF32	Top relatching device	



# Fire doors hardware

## CF60 solenoid Series

### Mechanical features

- » CF60 lock, cylinder not included, panic function for all versions
- » Suitable to be used in FR doors
- » Certified according UNE-EN1125:2009
- » Certified according UNE-EN 12209: 2004.
- » Steel latch, suitable to be used in FR doors
- » Non-friction guide between latch and frontplate
- » 9x9 mm follower
- » Backset 65 mm
- » Distance between each axis 72 mm
- » Reversible (non handed)
- » Front plate finish: zinc plated (Z) or stainless steel (I)

### Electrical features

- » Power supply: 12Vdc / 24Vdc
- » Consumption : max 550mA (12Vdc) / 270mA (24Vdc)
- » Consumption: stop 240mA (12Vdc) / 110mA (24Vdc)

Product code	Inner function	Frontplate finish
CF65NPTRSR9ICER	No Panic	Stainless steel
CF65NPTRSR9ZCER	No Panic	Zinc plated
CF65TRSR9ICEROB	Panic	Stainless steel
CF65TRSR9ZCEROB	Panic	Zinc plated
CF65IRSR9ICEROB	Panic (Inwards opening)	Stainless steel

### CF60 with panic function

#### Performance

- » Locking the cylinder, the external follower of the lock gets blocked and the door can not be opened. However, as it is an panic lock, the door can always be open from inside by activating the lever or the panic exit device.
- » With an electric signal, the electro switch clutches the inner mechanism of the lock allowing the door to be opened from outside operating the lever.
- » When the signal disappears, the lock becomes blocked again from outside.
- » Version "Inwards opening" (CF65IRSR9ICEROB) - only with Stainless Steel frontplate.

#### Certification

- » CE certified according UNE-EN12209 & UNE-EN1125

### CF60 without panic function

#### Performance

- » Locking the cylinder, the lock gets blocked and the door can not be opened, neither from inside nor from outside.
- » With an electric signal, the electro switch clutches the inner mechanism of the lock allowing the door to be opened from inside and outside operating the lever.
- » When the signal disappears, the lock becomes blocked again.

#### Certification

- » CE certified according UNE-EN12209.



CERTIFIED ACCORDING  
UNE-EN  
12209:2004  
1125:2009



### General dimensions

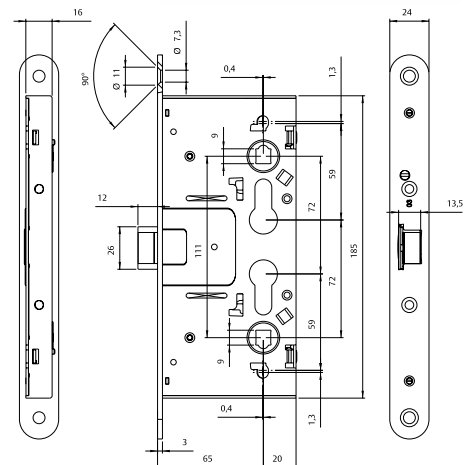

### Power consumption

Voltage
12-24 VDC (-10%/+15%)
Power consumption
máx. 550 mA (12 VDC)
nominal 240 mA (12 VDC)
máx. 270 mA (24 VDC)
nominal 110 mA (24 VDC)

### Installation

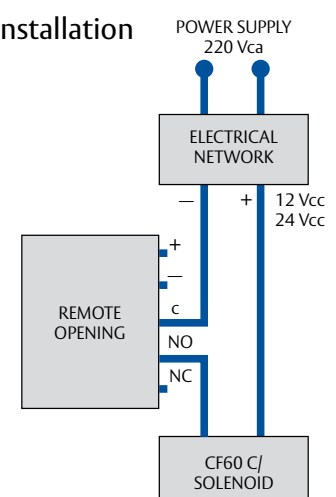

# Fire doors hardware

## 2UB0F Series

### Features

- » Mortise lock for wooden doors.
- » Conforms to the UNE-EN 12209 standard. EC-certified.
- » Reversible, silent latch in sintered steel. Profile of the latch: 17 mm (extra-security).
- » Distance between shafts: 85 mm.
- » Backsets: 60/70 mm.
- » By default, they include a panic exit function allowing for permanent free passage from the inside. With a double follower rod, an external protection device for the rod is installed in order to prevent the handle from being operated.
- » Steel follower rod: 8mm. Deadbolt follower rod: 6 mm
- » Optional round shape 1/2.
- » Closed body, which prevents shavings from entering at the time of installation.
- » TE-5 Europrofile cylinder with nickel steel keys. LP and HL finishes: cylinder's finish in brass. HN, AI and NE finishes: cylinder's finish in nickel.
- » Packaging in boxes of 1/20 units.

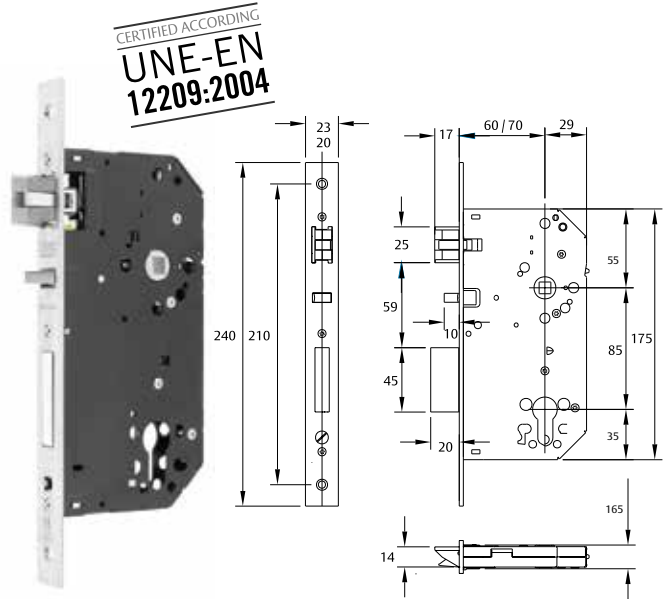

### Example antipanic standard follower product code

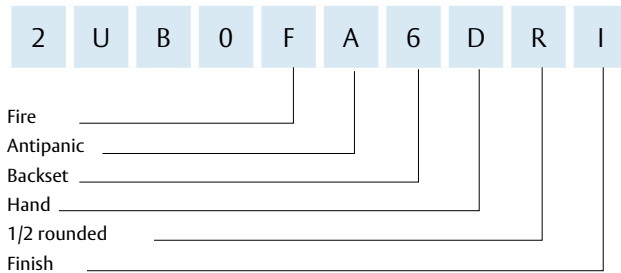

### Example non antipanic standard follower product code

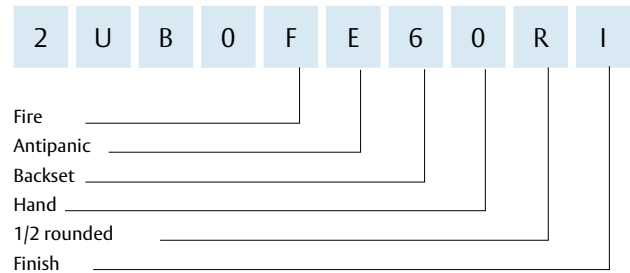

2UB0F	Model	Backset A	Finish	Packaging
	2UB0FA / FE	60 / 70	AI	1 / 20
	2UB0FA / FE	60 / 70	LP	1 / 20
2UB1F	Model	Backset A	Finish	Packaging
	2UB1F	60 / 70	AI	1 / 20
	2UB1F	60 / 70	LP	1 / 20
2UB4F	Model	Backset A	Finish	Packaging
	2UB4FA / FE	60 / 70	AI	1 / 20
	2UB4FA / FE	60 / 70	LP	1 / 20
2UB5F	Model	Backset A	Finish	Packaging
	2UB5F	60 / 70	AI	1 / 20
	2UB5F	60 / 70	LP	1 / 20

















2UB6	Model	Backset A	Finish	Packaging
	2UB6	60/70	AI	1 / 20
	2UB6	60/70	LP	1 / 20
	2UB6	60/70	AI	1 / 20
	2UB6	60/70	LP	1 / 20
2UB7F	Model	Backset A	Finish	Packaging
	2UB7F	60/70	AI	1 / 20
	2UB7F	60/70	LP	1 / 20
2UB9F	Model	Backset A	Finish	Packaging
	2UB9F	60/70	AI	1 / 20
	2UB9F	60/70	LP	1 / 20



# Handles for institutional buildings

## Fire doors Series

### Handles

														
			CF50/CF60	2030	CF50/CF60*	2030*			Fixed knobset*	Rotating knobset*				
Fixing system		Floating rapierts	Coach screw	Floating rapierts	Fixing rapierts Floating rapierts	Fixing rapierts			Sheet metal screw	Sheet metal screw	Floating rapierts	Floating rapierts	Floating rapierts	
	E0010EX	ME5L900	MS5L800	MSCF800	MSMF800				TTL800	TGL800	MS5800 (2030) MS5C8CF (CF50/CF60)	MSTT800	MSTT80V	
 85 mm	E0031EX		MS0L885				MSTF885				MS0C885			
 72 mm	E0061EX	ME0L972		MSMF872		MSTF872 METF972					MS0C872			

Depending on whether it is an entrance door, a passage door or an emergency exit, and also on the dimensions of the lock (distance between each axis of 85 or 72 mm), we will choose the most suitable model of handle or double handle.

\* Stainless steel finish - Flat knob  
Black finish - Ball knob

# Handles for institutional buildings

## Fire doors Series

### Sena Series

Fire rated and flame-resistant doors preserve the airtightness in a room where a fire has occurred, preventing the flames from spreading to other rooms in the building. The fitting (lock, handle, knob, door closer...) plays an important role here, ensuring the door remains completely closed and no heat or inflammable gases enter the room.

This chapter includes stainless steel handles and steel-based handles.

The Sena series has been certified by the LGAI and the EN 1634-1:2000 standard as a firebreak handle (minimum resistance to fire tests with the corresponding door: 120 minutes).

#### Firebreak spindles

In galvanized steel, capable of enduring high temperatures.

#### Steel reduction

Valves in 9 to 8 mm, 8 to 7 mm and 8 to 6 mm for firebreak locks.

#### Fixing of the handle

Depending on each model, fixing is carried out with fixed through bolts on the internal plate, or floating through bolts / bolts straight onto the door's leaf.



In this case you can order floating through bolts that will go through the door making the installation more resistant. Fixing screws will be hidden in order to prevent the handles from being stolen in public buildings.

#### Finishes

- » Stainless steel    AISI 316L
- » Black                Ral 9005

Model	Hand	For lock 2030F	For lock CF50-60	Model	Hand	For lock 2030F	For lock CF50-60
	-	MSOF885NE	MSOF872NE		-		MSMF872NE MSMF872IS16
	-	MSSF800NE	MSSF800NE		-	MSMF800NE MSMF800IS16	
	-	MSOF885IS16	MSOF872IS16		-		MSCF800NE MSCF800IS16
	-				Handle + pull handle	MSTF885NE*	
	-				Handle + pull handle	MSTF885IS16	
	-				P. handle + pull handle	MTFEL885IS16	door latch
	-				P. handle + pull handle	MTFOL885IS16**	
	-	MSMF885NE			Handle + pull handle		MSTF872NE*
	-	MSMF885IS16					MSTF872IS16
	-				P. handle + pull handle	TTFOL885IS16	

\* Black ball knob    \*\* Without studs

# Handles for institutional buildings

## Fire doors Series

### Monobloc Series

The MONOBLOC Series has been certified by the DIN 18273 standard for fire rated and flame-resistant doors.

#### Handle

Specifically aimed at doors subject to a big strain (hospitals, schools, public buildings).

The internal plate has been fixed to the handle with a black polypropylene coating.

The covers, made of the same material, have been fixed to the internal escutcheon with clips.

Models in which the handle has been attached to the square with a stud bolt (satin black finish) have been certified by the UNE - EN -1634 - 1: 2000 standard, with a 150 KG. resistance to motion strain and 200,000 actuations.

Specifically designed for locks with DIN sizes (72 mm distance between axis).

#### Fixing of the handle

Hidden by knurled floating through bolts that go through the door's leaf from the outside.



#### MONOBLOC Series Finishes



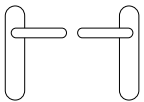
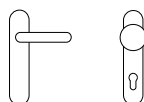
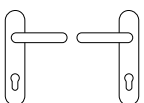
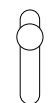
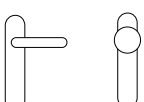
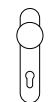
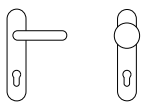





The steel-web handle has a black polypropylene coating has a matt black plypro that gives it rigidity and strength, high resistance to solvents, absence of electrostatic charge and stability against light and temperature variations.

Model	Product code	Finish	Model	Product code	Finish
	ME5L900 (Set of passage handles)	NM		METF72 (Half handle with keyhole at 72 mm and half passage knobset)	NM
	ME0L972 BME0L972 (Includes accessories to tighten the axis of the hinge)	NM		MPTF900 (Half passage knobset)	NM
	METF900 (Half handle and half passage knobset)	NM		MPTF972 (Half knobset with keyhole at 72mm)	NM
	METF972 (Half handle and half knobset with keyhole at 72 mm)	NM			

# Handles for institutional buildings

## Fire doors Series

### Monobloc Series

Model	Product code	Finishes	Model	Product code	Finishes
	PCM0L000 (Half blank cover)	NM		ECM0L072 (Half escutcheon only with keyhole at 72 mm in zinc plated steel)	NM
	PCM5L900 (Half passage cover)	NM		ECM5L900 (Half passage escutcheon in zinc plated steel)	NMN
	PCM0L072 (Half cover only keyhole at 72 mm)	NM		ACESTMONOBM5 (2 through bolts M5 monobloc range)	NM
	PCM0L972 (Half cover with keyhole at 72mm)	NM		ACCTENSOR BISCF (1000 tensors + CF hinges limit spring)	NM
	ECM0L000 (Half blank escutcheon in zinc plated steel)	NM			

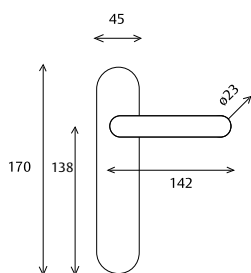



# Fire doors hardware

## Security multipoint locks TLPN and TLBA

- » Tempered steel levers.
- » Antilever hooks in auxiliary boxes.
- » Devices are protected by locked boxes made of galvanized steel.
- » Highly rigid U-profile steel front. Ideal for RF doors.
- » Security escutcheons E-700L, E300L, E700 and E800.
- » It can incorporate an embellishment for the key-storing escutcheon.
- » PATENTED no-return device for bolts and levers.
- » Long strikes in 40mm standard width with choice options in 35mm and 45mm. Also available in a special height of 2035mm.

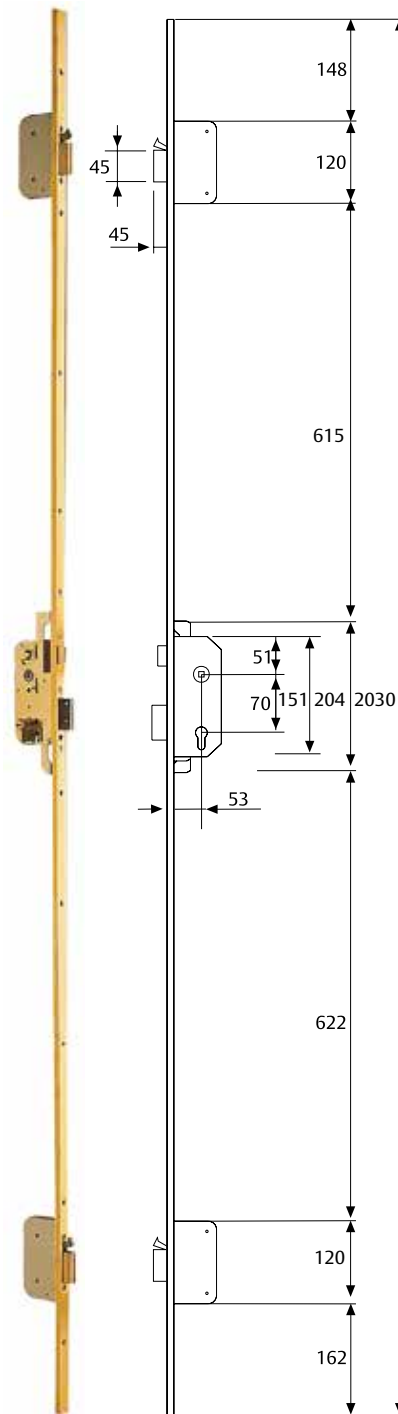
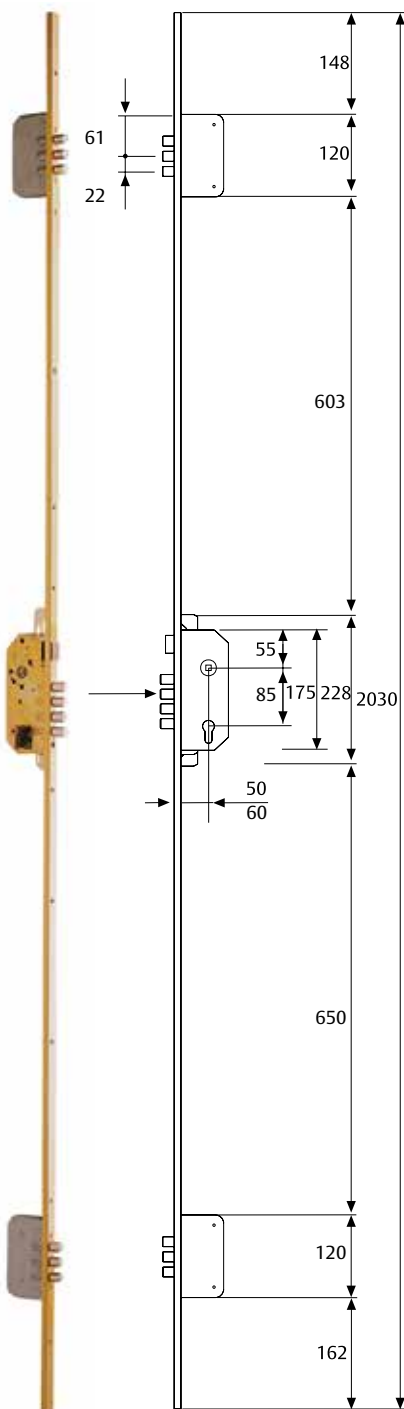

# Fire doors hardware

## Spindles and reducers

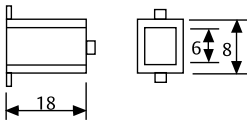
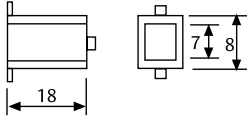
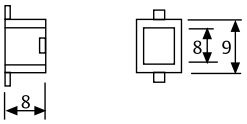
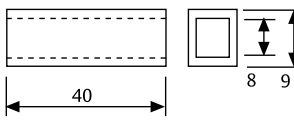
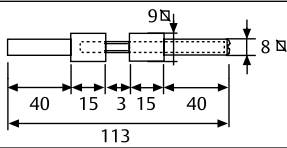
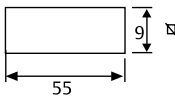
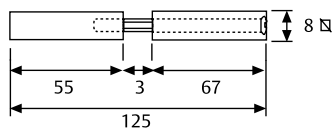
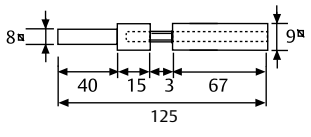
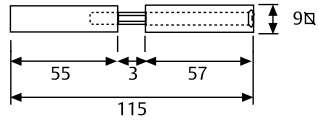
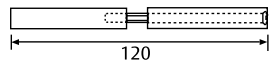
Models	Product code	Features	Packaging
	44600HH	From 8 to 6 mm For fire rated locks with single nut	50
	44700HH	From 8 to 7 mm For fire rated locks with single nut	50
	44900HH	From 9 to 8 mm For fire rated locks with double nut	50
	CASQUCF50	From 9 to 8 mm For fire rated locks with single nut	50
	CDCF60MAK	Double square spindle 8/9 + 9/8	
	CDCF60MAL	Spindle 9	
	CD2030S8M	Double square spindle 8/8 + 8/8	
	CDCF6089M	Double square spindle 8/9 + 9/9	
	DM9912CUA	Double square spindle 9/9 + 9/9	
	CDFUEGO8M	Fire double nut spindle 8x120	

# Fire doors hardware

## LITE - QUICK - Universal - TOP Series

- » CE market panic exit devices according to UNE-EN 1125.
- » Rim and mortice version available.
- » Single and multipoint locking panic exit devices, depending on door configuration and / or customer requirements.
- » Different outside device configuration available: knob, cylinder, handle...
- » Low projection devices maximizing the free passing area.
- » TESA panic exit devices are available in different finishes including stainless steel (AISI 304).
- » TESA panic exit devices can be combine with electromechanic devices for access control.
- » Refer to panic exit devices chapter for further information.



# Fire doors hardware

## Hinges for certified firebreak doors

- » 3mm thick steel hinge for break doors. Reversible.
- » Nickel-plated finish: shaft and leaf hinge.
- » Finish: without frame hinge treatment, to facilitate the welding process.
- » Spring hinges are supplied with tensioning tool.

	Reference	
	10 units	250 units
With hinge	BISCFM10	BISCFM250
With no hinge	BISCFM10	BISCFM250

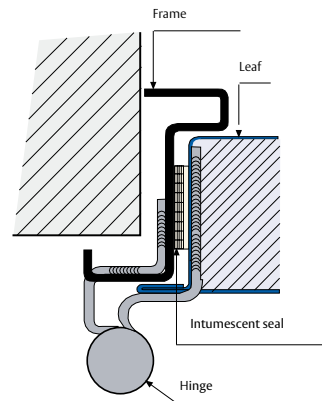
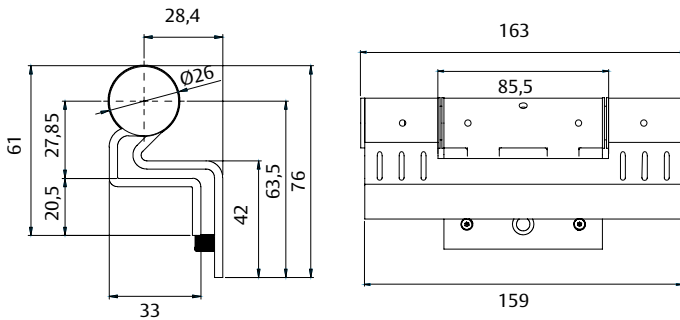

## Stainless Steel hinge

- » Stainless Steel hinge with two ball bearings for break fire doors
- » Extremely corrosion resistance, Grade 4. Reversible.
- » CE Certified according to EN1935:2002

4 7 5 1\* 1 4 0 13

Packing includes:

- » 1 set of Philips screws.

Product code	Finishes	Dimensions
BISCFCE433IS16	IS16	102x76x3 mm
BISCFCE443IS16	IS16	102x102x3 mm

Product code	Finishes	Dimensions
BISCFCE433IS	IS304	102x76x3 mm
BISCFCE443IS	IS304	102x102x3 mm

Product code	Finishes	Dimensions
BISCFCE433IS01	IS201	102x76x3 mm
BISCFCE443IS01	IS201	102x102x3 mm

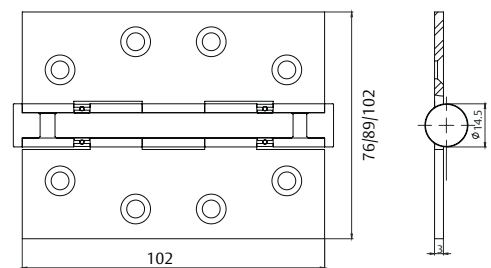



---

## **ASSA ABLOY**

Talleres de Escoriaza, S.A.U.  
Barrio Ventas, 35 • E-20305 Irun • SPAIN  
Tel.: +34 943 669 100 • Fax: +34 943 633 221  
[www.tesa.es](http://www.tesa.es)

ASSA ABLOY is the global leader in door opening solutions,  
dedicated to satisfying end-user needs for security, safety and convenience