

# Knobsets

TESA

ASSA ABLOY



# Specialists and leaders in knobsets



More than 40 years manufacturing locksets have made of [TESA](#) an unavoidable reference in the market for the most widely spread type of lock in the world: the lockset, a very simple, easy-to-install product with endless possibilities.

## Easy to install

TESA's lockset is a very easy to install product. In 3 steps we can equip the door and have it perfectly ready to operate.

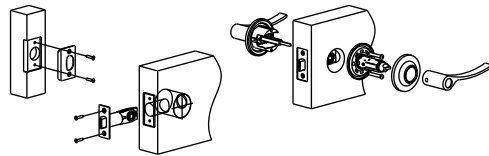

## Wide range of functions and finishes

With a 40-year experience in the manufacturing of locksets, TESA can offer you the widest range of finishes and functions required in every case. Free passage doors, doors that require privacy, doors to be controlled with a key, pull handles and many others have proven to meet the market's demands while being at the same time subject to the requisites of each finish. Brass, chrome, nickel, black, white finishes... all of them carefully conceived to last many years.



## Masterkeyings and security cylinders

Do you want control, comfort and security in one lockset?

Don't hesitate to choose a masterkeying with our dimple key security cylinders. A masterkeying will allow you to open more than one door, restrict the access of certain users to certain doors and rely on the security that you need, using a very limited number of keys (or even just one, if necessary).



## Replacement

The great advantage of locksets is the possibility of changing and updating the aesthetics of the door as well as the finish or the function installed in it with no need to mechanize the door again; just replacing the lock with a new one will be enough.



## Certified products

TESA's lockset is not only a simple, easy-to-install product; it's also highly resistant, with a very lasting fixing. This is borne out by the meeting of the ANSI and UL standards, which are proof of the high level of resistance and durability of the product even in cases of fire.

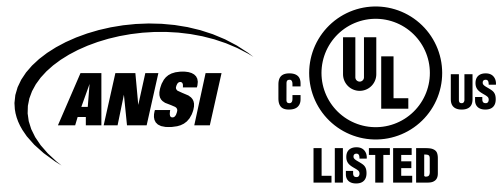

## Guaranteed by TESA

To buy TESA is a quality guarantee. TESA's lockset is a totally reliable product, whose manufacturing and design provide the maximum guarantee of quality and environmental awareness, accredited by the ISO 9001 and ISO 14001 certifications and the Security at Work and Occupational Hazard Prevention standard.



# Finish index



Polished brass  
LP



Satin brass  
LM



Polished chrome  
CR



Satin chrome  
CM



Antique brass  
LA



Satin nickel  
NS



Black nickel  
MB



White  
BL



Black  
NE



Gold enameled  
AE

# Index

## Contents

<b>Key-in-lever locksets</b>	<b>6</b>
Functions	7
Key-in-lever locksets	8
3F00 Flare series	8
3B00 Barcelona series	9
3A00 Arko series	9
3H00 Hermes series	10
3T00 Toledo series	10
3J00 Jerez series	11
3G00 Granada series	11
3900 Bola series	12
3500 Tulipa series	13
3800 Nobel series	14
3550 California series	14
<b>Deadlocks</b>	<b>15</b>
514 deadlocks	15
517 deadlocks	15
516 deadlocks	15
<b>Decorative escutcheons</b>	<b>16</b>
<b>Latches and strikes</b>	<b>17</b>
Key-in-lever latch	17
Bolt for 516 and 517	17
Strikes	17
<b>Access collection</b>	<b>18</b>
Standards	19
Technical data	20
Models	20
Functions	21
Finishes	21
<b>Rose 50 mm</b>	<b>23</b>
Coma	23
Luna	24
Mira	25
<b>Escutcheon 65 mm</b>	<b>26</b>
Coma	26
Luna	27
Mira	28



Key-in-lever locksets



Deadlocks



Decorative escutcheon



Latches and strikes



ACCESS collection

# Key-in-lever locksets

## Squaring the advantages

- » Multifunctional mechanism for knob or lever, with high component robustness and soft operation.
- » High-end commercial and residential applications.

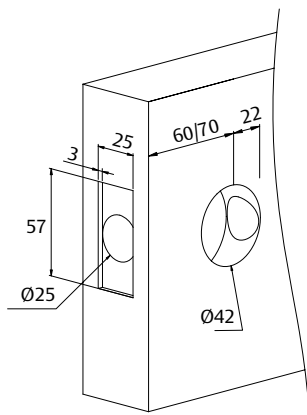



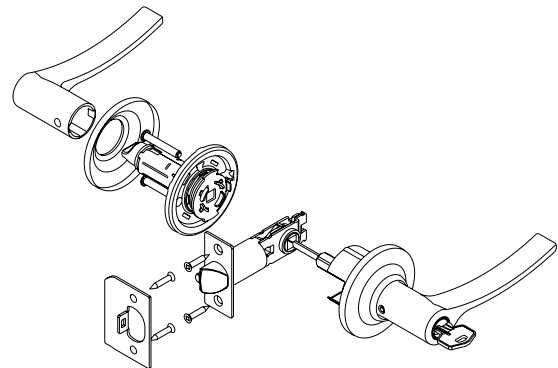





Dimensions in mm

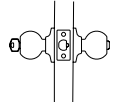
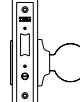
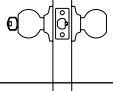

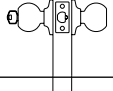
Features	Standard	Special
Technical features	Anti-thrust security pin for functions 0, 1 and 2.	Panic release system: in key models, even when locked, the door can always be opened from inside.
Anti-corrosion resistance ASTM B117/90	CR,CM,NS ... 144 hours LP,LM... 96 hours	
Door thickness	33-45 mm for handles. 33-52 mm for knobs. Except function 07: 40-50mm	Up to 75 mm
ANSI A156.2	Grade 2: 400.000 cycles.	
UL		Up to 1,5 hours of Fire proof
Cylinder	5 pin cylinder with 3 keys.	Security Cylinder: T60, T80, TX80, T10, T12. Masterkeying and keyed alike.
Latch	60/70 Adjustable backset. Latchbolt projection 12,5 mm	127 mm rounded forend.
Accessories	Strike, screws, instructions and assembly template.	Rounded strike.
Packaging units	20	
Reversibility	All knobsets are reversible - Beware with the hands of some handles	

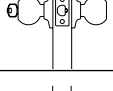
# Key-in-lever locksets

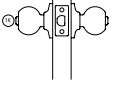
## Functions

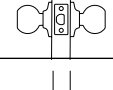
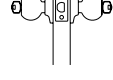
Function	Description	Function	Description
 00	ENTRANCE LOCK: both sides are locked and unlocked by outside key or inside turn-button.	 20	ENTRANCE LOCK: both sides are locked and unlocked by outside key or inside knob. Mortise lock. Applicable with electric strike.
 01	ENTRANCE LOCK: locked and unlocked only by outside key. If locked, inside knob/lever is not active.	 31	SINGLE DUMMY TRIM: screw attachment from inside of the door.
 01AP	ENTRANCE LOCK: locked and unlocked only by outside key. Inside always unlocked.	 32	DOUBLE DUMMY TRIM
 02	STOREROOM LOCK: outside fixed, entrance by key only. Inside always unlocked.	 33	ENTRANCE LOCK: both sides always unlocked. Applicable to mortise locks.
 03	BED AND BATHROOM LOCKS: both sides are locked and unlocked by the inside turn-button. Emergency release outside.	 34	ENTRANCE LOCK: always unlocked. Applicable to mortise locks.
 05	PASSAGE LOCK: both sides always unlocked.		
 07	OFFICE LOCK: key locks and unlocks each side separately. Leaf thickness: 40-50mm		

## Code interpretation

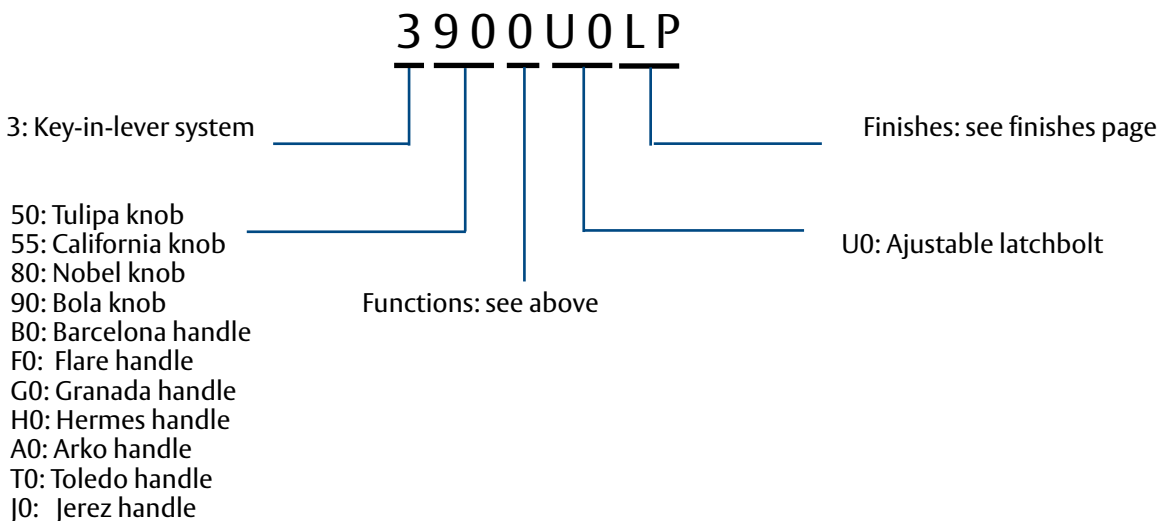

# Key-in-lever locksets

## Handle model

Model	A	B	C	Model	A	B	C
Arko	65	62	112	Hermes	65	62	109
Barcelona	65	62	109	Jerez	65	62	115
Flare	65	62	107	Toledo	65	62	121
Granada	65	62	119				

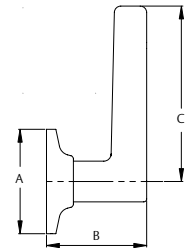

3A00 Arko                      3B00 Barcelona



3F00 Flare                      3G00 Granada



3H00 Hermes                      3J00 Jerez



3T00 Toledo



## 3F00 Flare series



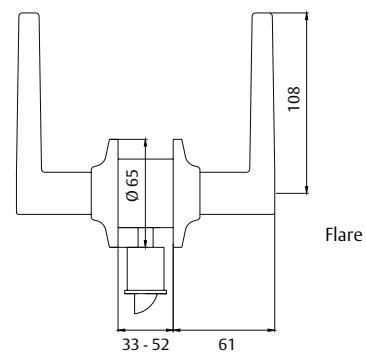





Entrance	Function	Backset	Finish	Packging
	3F00	U0	CM - CR - LM - LP - NS LA - BL - NE	20
Storeroom	Function	Backset	Finish	Packging
	3F02D	U0	CM - CR - LM - LP - NS LA - BL - NE	20
Storeroom	Function	Backset	Finish	Packging
	3F02I	U0	CM - CR - LM - LP - NS LA - BL - NE	20
Bathroom	Function	Backset	Finish	Packging
	3F03	U0	CM - CR - LM - LP - NS LA - BL - NE	20
Passage	Function	Backset	Finish	Packging
	3F05	U0	CM - CR - LM - LP - NS LA - BL - NE	20
Offices	Function	Backset	Finish	Packging
	3F07	U0	CM - CR - LM - LP - NS LA - BL - NE	20
Pull lever	Function	Backset	Finish	Packging
	3F34D	00	CM - CR - LM - LP - NS LA - BL - NE	20
Single spindle	Function	Backset	Finish	Packging
	3F34I	00	CM - CR - LM - LP - NS LA - BL - NE	20











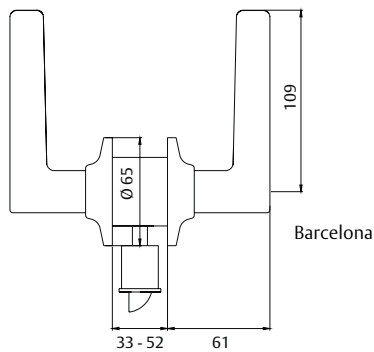

# Key-in-lever locksets

## 3B00 Barcelona series

Entrance	Function	Backset	Finish	Packging
	3B00	U0	CM - CR - LM - LP - NS LA - BL - NE	20
Storeroom	Function	Backset	Finish	Packging
	3B02D	U0	CM - CR - LM - LP - NS LA - BL - NE	20
Storeroom	Function	Backset	Finish	Packging
	3B02I	U0	CM - CR - LM - LP - NS LA - BL - NE	20
Bathroom	Function	Backset	Finish	Packging
	3B03	U0	CM - CR - LM - LP - NS LA - BL - NE	20
Passage	Function	Backset	Finish	Packging
	3B05	U0	CM - CR - LM - LP - NS LA - BL - NE	20
Office	Function	Backset	Finish	Packging
	3T07	U0	CM - CR - LM - LP - NS LA - BL - NE	20
Single spindle	Function	Backset	Finish	Packging
	3B34D	00	CM - CR - LM - LP - NS LA - BL - NE	20
Single spindle	Function	Backset	Finish	Packging
	3B34I	00	CM - CR - LM - LP - NS LA - BL - NE	20







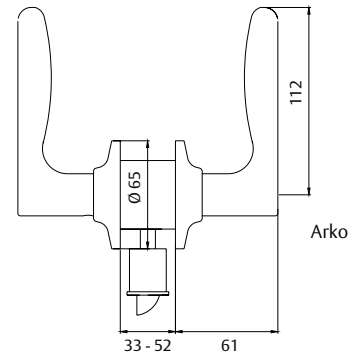



## 3A00 Arko series

Entrance	Function	Backset	Finish	Packging
	3A00	U0	CM - CR - LM - LP - NS LA - BL - NE	20
Storeroom	Function	Backset	Finish	Packging
	3A02D	U0	CM - CR - LM - LP - NS LA - BL - NE	20
Storeroom	Function	Backset	Finish	Packging
	3A02I	U0	CM - CR - LM - LP - NS LA - BL - NE	20
Bathroom	Function	Backset	Finish	Packging
	3A03	U0	CM - CR - LM - LP - NS LA - BL - NE	20
Passage	Function	Backset	Finish	Packging
	3A05	U0	CM - CR - LM - LP - NS LA - BL - NE	20
Office	Function	Backset	Finish	Packging
	3A07	U0	CM - CR - LM - LP - NS LA - BL - NE	20
Single spindle	Function	Backset	Finish	Packging
	3A34D	00	CM - CR - LM - LP - NS LA - BL - NE	20
Single spindle	Function	Backset	Finish	Packging
	3A34I	00	CM - CR - LM - LP - NS LA - BL - NE	20







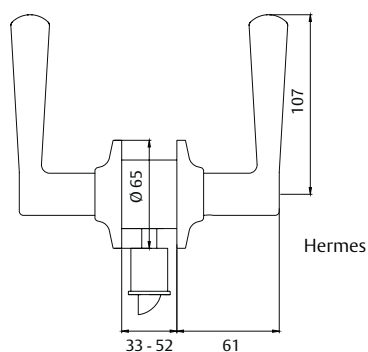

# Key-in-lever locksets

## 3H00 Hermes series

Entrance	Function	Backset	Finish	Packging
	3H00	U0	CM - CR - LM - LP - NS LA - BL - NE	20
Storeroom	Function	Backset	Finish	Packging
	3H02D	U0	CM - CR - LM - LP - NS LA - BL - NE	20
Storeroom	Function	Backset	Finish	Packging
	3H02I	U0	CM - CR - LM - LP - NS LA - BL - NE	20
Bathroom	Function	Backset	Finish	Packging
	3H03	U0	CM - CR - LM - LP - NS LA - BL - NE	20
Passage	Function	Backset	Finish	Packging
	3H05	U0	CM - CR - LM - LP - NS LA - BL - NE	20
Office	Function	Backset	Finish	Packging
	3H07	U0	CM - CR - LM - LP - NS LA - BL - NE	20
Single spindle	Function	Backset	Finish	Packging
	3H34D	00	CM - CR - LM - LP - NS LA - BL - NE	20
Single spindle	Function	Backset	Finish	Packging
	3H34I	00	CM - CR - LM - LP - NS LA - BL - NE	20







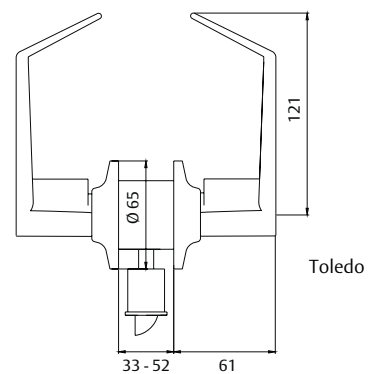

## 3T00 Toledo series

Entrance	Function	Backset	Finish	Packging
	3T00	U0	CM - CR - LM - LP - NS LA - BL - NE	20
Storeroom	Function	Backset	Finish	Packging
	3T02	U0	CM - CR - LM - LP - NS LA - BL - NE	20
Bathroom	Function	Backset	Finish	Packging
	3T03	U0	CM - CR - LM - LP - NS LA - BL - NE	20
Passage	Function	Backset	Finish	Packging
	3T05	U0	CM - CR - LM - LP - NS LA - BL - NE	20
Office	Function	Backset	Finish	Packging
	3T07	U0	CM - CR - LM - LP - NS LA - BL - NE	20
Single spindle	Function	Backset	Finish	Packging
	3T34	00	CM - CR - LM - LP - NS LA - BL - NE	20







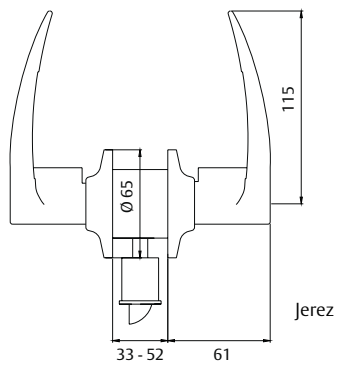

# Key-in-lever locksets

## 3J00 Jerez series

Entrance	Function	Backset	Finish	Packging
	3J00	U0	CM - CR - LM - LP - NS LA - BL - NE	20
Storeroom	Function	Backset	Finish	Packging
	3J02	U0	CM - CR - LM - LP - NS LA - BL - NE	20
Bathroom	Function	Backset	Finish	Packging
	3J03	U0	CM - CR - LM - LP - NS LA - BL - NE	20
Passage	Function	Backset	Finish	Packging
	3J05	U0	CM - CR - LM - LP - NS LA - BL - NE	20
Office	Function	Backset	Finish	Packging
	3J07	U0	CM - CR - LM - LP - NS LA - BL - NE	20
Single spindle	Function	Backset	Finish	Packging
	3J34	00	CM - CR - LM - LP - NS LA - BL - NE	20



## 3G00 Granada series



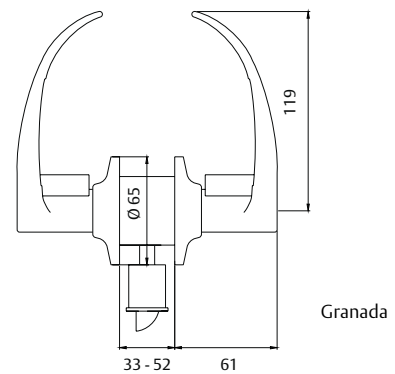



Entrance	Function	Backset	Finish	Packging
	3G00	U0	CM - CR - LM - LP - NS LA - BL - NE	20
Storeroom	Function	Backset	Finish	Packging
	3G02	U0	CM - CR - LM - LP - NS LA - BL - NE	20
Bathroom	Function	Backset	Finish	Packging
	3G03	U0	CM - CR - LM - LP - NS LA - BL - NE	20
Passage	Function	Backset	Finish	Packging
	3G05	U0	CM - CR - LM - LP - NS LA - BL - NE	20
Office	Function	Backset	Finish	Packging
	3G07	U0	CM - CR - LM - LP - NS LA - BL - NE	20
Single spindle	Function	Backset	Finish	Packging
	3G34	00	CM - CR - LM - LP - NS LA - BL - NE	20



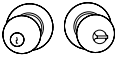



E

# Key-in-lever locksets

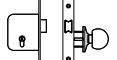
## 3900 Bola series

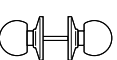
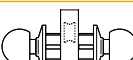

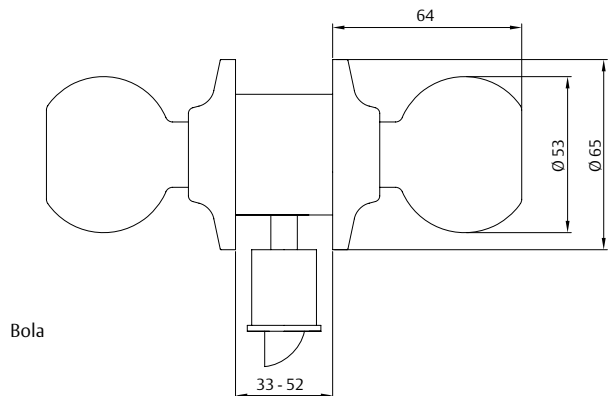

Entrance	Function	Backset	Finish	Packging
	3900	U0 UV	CM - CR - LM - LP - NS LA - BL - NE - AE	20
Entrance	Function	Backset	Finish	Packging
	3901	U0	CM - CR - LM - LP - NS LA - BL - NE - AE	20
Entrance	Function	Backset	Finish	Packging
	3901AP	U0	CCM - CR - LM - LP - NS LA - BL - NE - AE	20
Storeroom	Function	Backset	Finish	Packging
	3902	U0	CM - CR - LM - LP - NS LA - BL - NE - AE	20
Bathroom	Function	Backset	Finish	Packging
	3903	U0 UV	CM - CR - LM - LP - NS LA - BL - NE - AE	20
Passage	Function	Backset	Finish	Packging
	3905	U0 UV	CM - CR - LM - LP - NS LA - BL - NE - AE	20



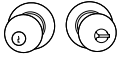
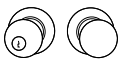

Office	Function	Backset	Finish	Packging
	3907	U0	CM - CR - LM - LP - NS LA - BL - NE - AE	20
Entrance	Function	Backset	Finish	Packging
	3920	50	CM - CR - LM - LP - NS LA - BL - NE - AE	20
Single pull knob	Function	Backset	Finish	Packging
	3931	00	CM - CR - LM - LP - NS LA - BL - NE - AE	20
Double pull knob	Function	Backset	Finish	Packging
	3932	00	CM - CR - LM - LP - NS LA - BL - NE - AE	20
Double sq.spindle	Function	Backset	Finish	Packging
	3933	00	CM - CR - LM - LP - NS LA - BL - NE - AE	20
Single sq.spindle	Function	Backset	Finish	Packging
	3934	00	CM - CR - LM - LP - NS LA - BL - NE - AE	20

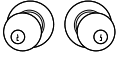

# Key-in-lever locksets

## 3500 Tulipa series

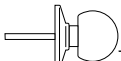
Entrance	Function	Backset	Finish	Packging
	3500	U0 UV	CM - CR - LM - LP - NS LA - BL - NE - AE	20
Entrance	Function	Backset	Finish	Packging
	3501	U0	CM - CR - LM - LP - NS LA - BL - NE - AE	20
Entrance	Function	Backset	Finish	Packging
	3501AP	U0	CM - CR - LM - LP - NS LA - BL - NE - AE	20
Storeroom	Function	Backset	Finish	Packging
	3502	U0	CM - CR - LM - LP - NS LA - BL - NE - AE	20
Bathroom	Function	Backset	Finish	Packging
	3503	U0 UV	CM - CR - LM - LP - NS LA - BL - NE - AE	20
Passage	Function	Backset	Finish	Packging
	3505	U0 UV	CM - CR - LM - LP - NS LA - BL - NE - AE	20

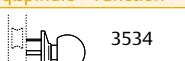
Office	Function	Backset	Finish	Packging
	3507	U0	CM - CR - LM - LP - NS LA - BL - NE - AE	20
Entrance	Function	Backset	Finish	Packging
	3520	U0	CM - CR - LM - LP - NS LA - BL - NE - AE	20
Single Pull knob	Function	Backset	Finish	Packging
	3531	U0	CM - CR - LM - LP - NS LA - BL - NE - AE	20
Double pull knob	Function	Backset	Finish	Packging
	3532	U0	CM - CR - LM - LP - NS LA - BL - NE - AE	20
Double sq.spindle	Function	Backset	Finish	Packging
	3533	U0	CM - CR - LM - LP - NS LA - BL - NE - AE	20
Single sq.spindle	Function	Backset	Finish	Packging
	3534	U0	CM - CR - LM - LP - NS LA - BL - NE - AE	20

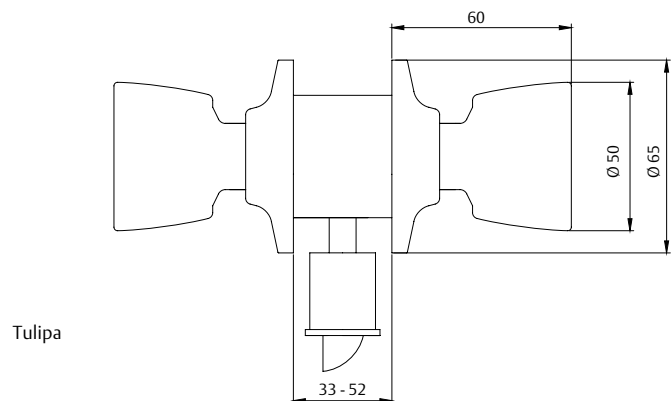

# Deadlocks

## 514 deadlocks

» Deadlock with ADA turn button inside, making easier the opening. Non bolt through fixing from inside.

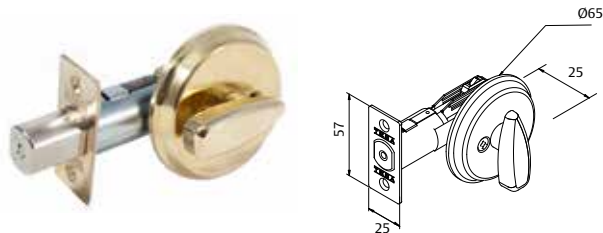

Model	Backset	Finish	Packging
514	U0	CM - CR - LM - LP - NS - LA	20

## 516 deadlocks

» Deadlock with cylinder outside and ADA turn button inside, making easier the opening.

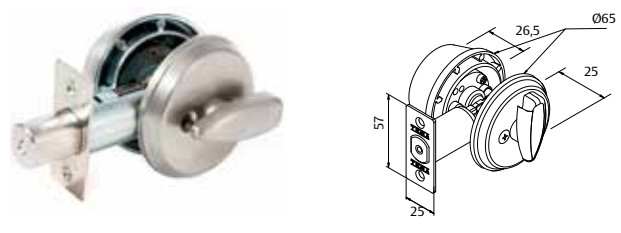

Model	Backset	Finish	Packging
516	U0	CM - CR - LM - LP - NS - LA	20

## 517 deadlocks

» Double cylinder, internal and external key operation.

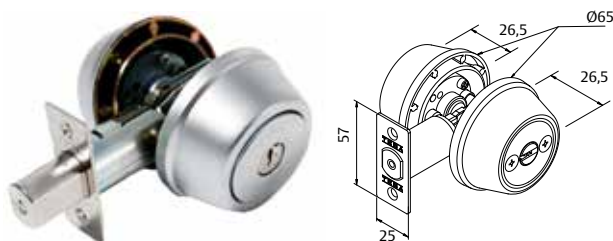

Model	Backset	Finish	Packging
517	U0	CM - CR - LM - LP - LA - NS	20

Features	Standard	Special
Anti-corrosion resistance according ASTM B117/90	CR,CM ....144 hours LP, LM.....96 hours	
Door thickness	33-47 mm in 514 33-52 mm in 516, 517	Up to 72 mm for 514. Up to 70 mm for 516.
ANSI A156.2	Grade 3: 100.000 cycles	
UL	ANSI A156.5	Up to 1,5 hours.
Thumb turn	ADA that makes operation easier	
Cylinder	5 active pins and 3 keys	Security Cylinder: T60, T80, TX80 Masterkeying and keyed alike.
Latchbolt	60/70 Ajustable backset. and with anti saw device	
Accessories	Strike plate, screws, instructions and templates	Rounded strikes
Packaging units	20	

# Decorative escutcheons

461 / 45 Model      Finish      Packaging

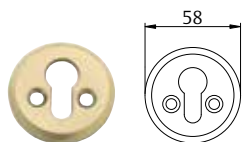

CM - CR - LM - LP  
NS - LN      10

452 / 90 Model      Finish      Packaging

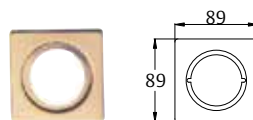

CM - LM - LP      10

469 / ED Model      Finish      Packaging

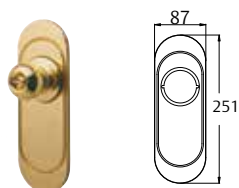

CM - LM - LP      10

453 / 26 Model      Finish      Packaging

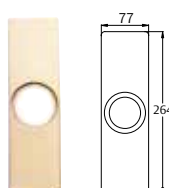

CM - LM - LP      10

\* Keyholes are not performed.

\* Keyholes are not performed.



# Latches and strikes

## Key-in-lever latch

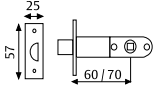
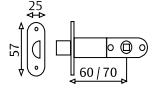
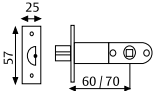
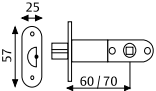
Standard	Model	Finishes	Size	Packging
	P030U0	LP - CR	60/70	200
	P03020	LP - CR	127	100
1/2 rounded	Model	Finishes	Size	Packging
	P030U2	LP - CR	60/70	200
Security device	Model	Finishes	Size	Packging
	P031U0	LP - CR	60/70	200
	P03120	LP - CR	127	100
Security device and 1/2 rounded	Model	Finishes	Size	Packging
	P031U2	LP - CR	60/70	200

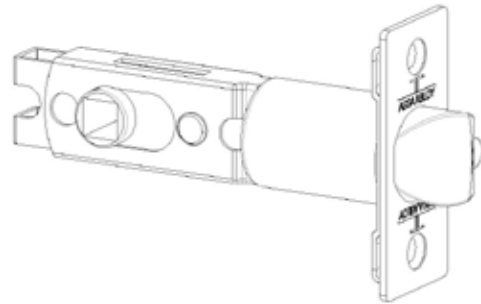

## Bolt for 516 and 517

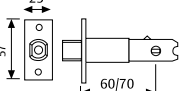
Standard	Model	Finishes	Size	Packging
	P016U0	LP - CR	60/70	200

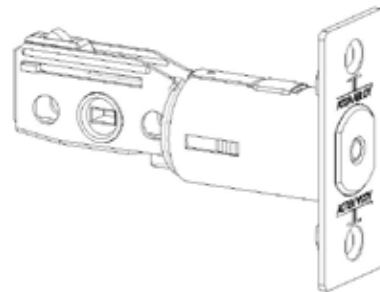

## Strikes

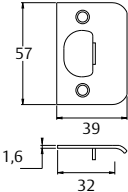
Standard	Model	Finishes	Packging
	C2500	HL	800
	C2500	HN	800

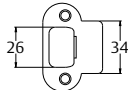
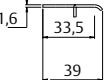
1/2 rounded	Model	Finishes	Packging
	CR25 / 34	HL	1000
	CR25 / 34	HN	1000
			







---

## **ASSA ABLOY**

Talleres de Escoriaza, S.A.U.  
Barrio Ventas, 35 • E-20305 Irun • SPAIN  
Tel.: +34 943 669 100 • Fax: +34 943 633 221  
[www.tesa.es](http://www.tesa.es)

ASSA ABLOY is the global leader in door opening solutions,  
dedicated to satisfying end-user needs for security, safety and convenience.